

## Multiway ball valves KH3 / KH4

### Model code

(also order example)

**KH3** **G1/2** **L** **1114** **06** **X**

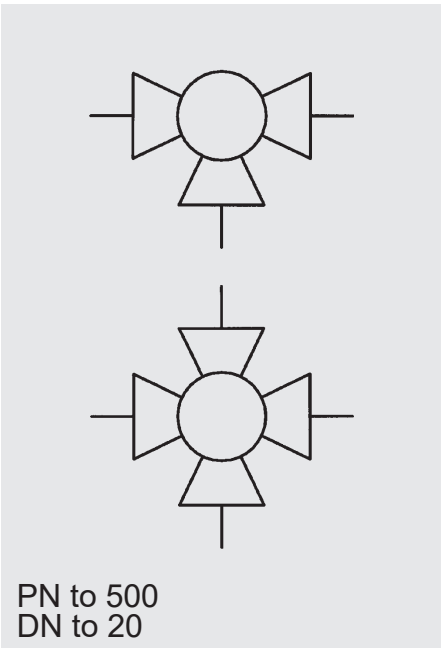

### Designation

KH3 = 3-way ball valve  
KH4 = 4-way ball valve

### Type of connection

G = Whitworth female thread ISO 228  
LR = threaded connection - light range DIN 2353  
SR = threaded connection - heavy range DIN 2353  
NPT = female thread ANSI B 1.20.1  
SAE = female thread SAE J 514 UN/UNF

### Ball bore

KH3 - L  
KH3 - T  
KH4 - T  
KH4 - X

### Materials

#### Housing, connection adapters

1 = steel  
3 = stainless steel

#### Ball, control spindle

1 = steel  
3 = stainless steel

#### Ball seal

1 = POM  
3 = PTFE  
8 = PEEK

#### Control spindle seal

2 = NBR (Perbunan)  
4 = FKM (Viton)

### Handle

01 = aluminium clamped handle, straight  
02 = aluminium clamped handle, cranked  
03 = zinc die-cast clamped handle, straight  
04 = zinc die-cast bolt-on handle, cranked  
06 = steel bolt-on handle, cranked  
09 = without handle

### Series

(determined by manufacturer)

## Standard model functions

(available as standard)

3-way ball valve L bore, 90°, pos.

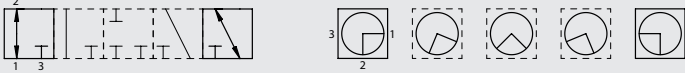

3-way ball valve T bore, 90°, pos.

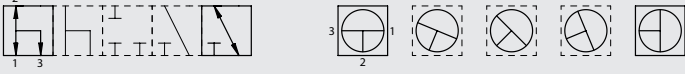

4-way ball valve T bore, 90°, pos.

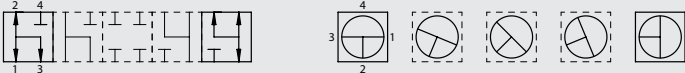

4-way ball valve X bore, 90°, pos.

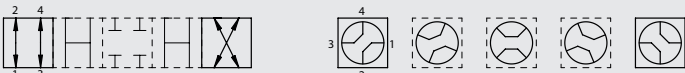

## Non-standard model functions

For different applications, it is possible to produce other non standard models by using special limit discs and detent pins.

3-way ball valve SO 926, 90°, pos.



3-way ball valve SO 376, 45°, neg.



3-way ball valve SO 377, 45°, neg.



3-way ball valve 180°, pos.



3-way ball valve SO 926.1, 180°, pos.



3-way ball valve SO 926.2, 180°, pos.



3-way ball valve SO 378, 90°, pos.



3-way ball valve SO 379, 90°, pos.

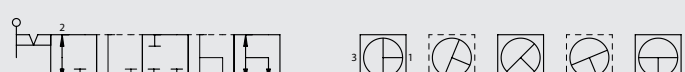

3-way ball valve SO 381, 90°, neg.



3-way ball valve SO 382, 90°, neg.

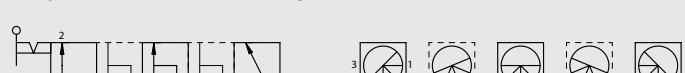

3-way ball valve SO 380, 90°, neg.



4-way ball valve SO 384, 45°, neg.

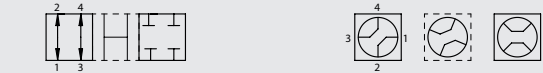

4-way ball valve SO 383, 45°, neg.

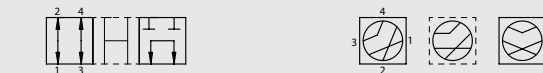

4-way ball valve 180°, pos.

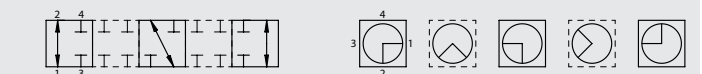

4-way ball valve 180°, pos.

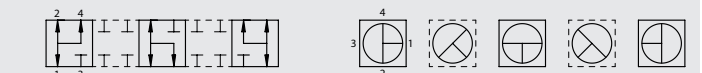

4-way ball valve SO 385, 90°, pos.

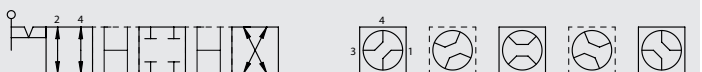

4-way ball valve SO 389, 90°, pos.



4-way ball valve SO 388, 90°, neg.



4-way ball valve SO 391, 90°, neg.

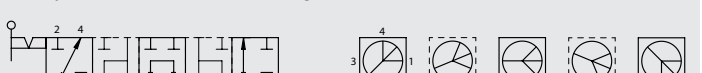

4-way ball valve SO 386, 90°, neg.

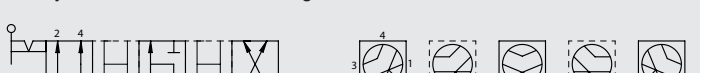

4-way ball valve SO 392, 90°, neg.

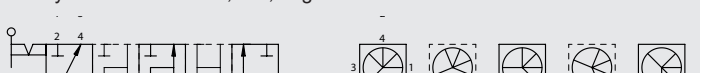

4-way ball valve SO 387, 90°, neg.

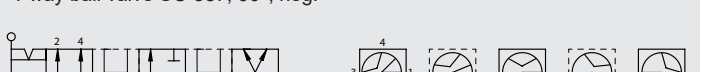

4-way ball valve SO 390, 90°, neg.

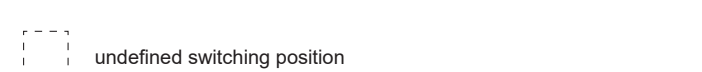
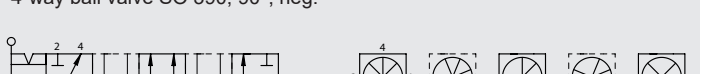

undefined switching position

Centre position (45°) detented

## Technical specifications

Types of connection:	Light and heavy threaded connection to DIN 2353 Whitworth female thread to ISO 228 NPT SAE
Mounting position:	No orientation restrictions
Ambient temperature:	-10 °C to +80 °C
Nominal pressure:	up to PN 500
Operating fluids:	Mineral oil to DIN 51524 part 1 and part 2 (other fluids on request)
Temperature of operating fluid:	-10 °C to +80 °C
Spare parts:	Seal kits available on request

## Dimensions

3-way and 4-way ball valves

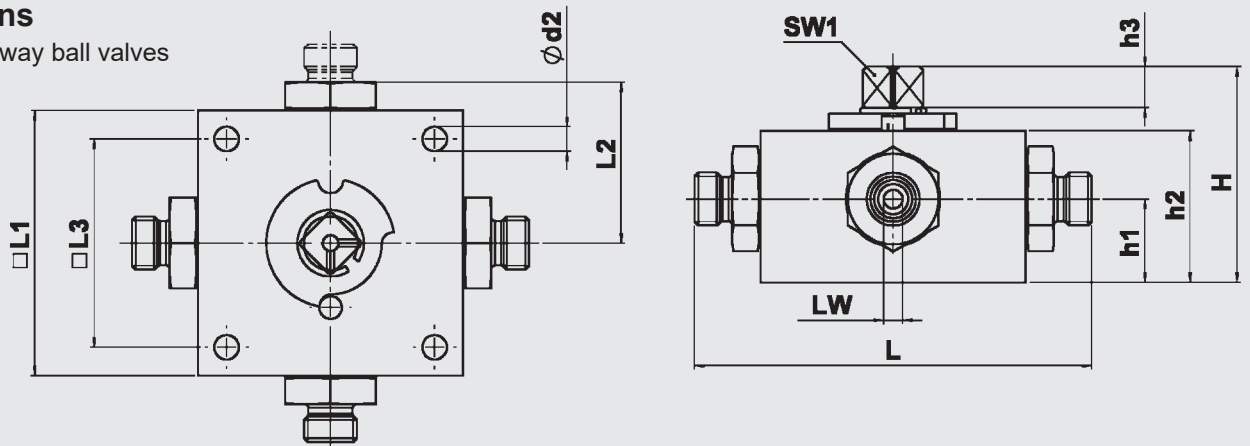

Type	DN	Bore int. diam.			RA	d1	l	L	L1	L2	L3	H	h1	h2	h3	d2	SW1	SW2	Weight [kg]	Nom. press. PN [bar]
		L	T	X																
KH3/4-G1/8	4	6	6	4.5		G1/8	10	100	70	42.5	55	57	22	40	11	6.5	12	24	1.6	500
KH3/4-G1/4	6	6	6	4.5		G1/4	14	100	70	42.5	55	57	22	40	11	6.5	12	24	1.6	500
KH3/4-G3/8	10	9	9	6		G3/8	14	115	80	46	65	67.5	27	50	11.5	6.5	14	30	2.4	500
KH3/4-G1/2	16	13	13	10		G1/2	16	135	100	56	80	77.5	31	60	11.5	9	14	36	4.3	400
KH3/4-G3/4	20	18	18	14		G3/4	18	144	100	58	85	91	36	73	11.5	9	17	46	6	315

Type	DN	Bore int. diam.			RA	d1	l	L	L1	L2	L3	H	h1	h2	h3	d2	SW1	SW2	Weight [kg]	Nom. press. PN [bar]
		L	T	X																
KH3/4-06LR	4	6	6	4.5	6	M12x1.5	10	105	70	42.5	55	57	22	40	11	6.5	12	24	1.6	500
KH3/4-08LR	6	6	6	4.5	8	M14x1.5	10	105	70	42.5	55	57	22	40	11	6.5	12	24	1.6	500
KH3/4-10LR	8	9	9	6	10	M16x1.5	11	114	80	46	65	67.5	27	50	11.5	6.5	14	30	2.4	500
KH3/4-12LR	10	9	9	6	12	M18x1.5	11	114	80	46	65	67.5	27	50	11.5	6.5	14	30	2.4	500
KH3/4-15LR	12	13	13	10	15	M22x1.5	12	136	100	56	80	77.5	31	60	11.5	9	14	36	4.3	400
KH3/4-18LR	16	13	13	10	18	M26x1.5	12	136	100	56	80	77.5	31	60	11.5	9	14	36	4.3	400
KH3/4-22LR	20	18	18	14	22	M30x2	14	143	100	58	85	91	36	73	11.5	9	17	46	6	315

Type	DN	Bore int. diam.			RA	d1	l	L	L1	L2	L3	H	h1	h2	h3	d2	SW1	SW2	Weight [kg]	Nom. press. PN [bar]
		L	T	X																
KH3/4-08SR	4	6	6	4.5	8	M16x1.5	12	105	70	42.5	55	57	22	40	11	6.5	12	24	1.6	500
KH3/4-10SR	6	6	6	4.5	10	M18x1.5	12	105	70	42.5	55	57	22	40	11	6.5	12	24	1.6	500
KH3/4-12SR	8	9	9	6	12	M20x1.5	12	116	80	46	65	67.5	27	50	11.5	6.5	14	30	2.4	500
KH3/4-14SR	10	9	9	6	14	M22x1.5	14	120	80	46	65	67.5	27	50	11.5	6.5	14	30	2.4	500
KH3/4-16SR	12	13	13	10	16	M24x1.5	14	140	100	56	80	77.5	31	60	11.5	9	14	36	4.3	400
KH3/4-20SR	16	13	13	10	20	M30x2	16	144	100	56	80	77.5	31	60	11.5	9	14	36	4.3	400
KH3/4-25SR	20	18	18	14	25	M36x2	18	151	100	58	85	91	36	73	11.5	9	17	46	6	315

Type	DN	Bore int. diam.			RA	d1	l	L	L1	L2	L3	H	h1	h2	h3	d2	SW1	SW2	Weight [kg]	Nom. press. PN [bar]
		L	T	X																
KH3/4-06NPT	6	6	6	4.5		1/4 - 18 NPT	10.21	100	70	42.5	55	83	22	40	11	6.5	12	24	1.75	500
KH3/4-10NPT	10	9	9	6		3/8 - 18 NPT	10.36	115	80	46	65	63.5	27	50	11.5	6.5	14	30	2.7	500
KH3/4-12NPT	12	13	13	10		1/2 - 14 NPT	13.56	135	100	56	85	75.5	31	60	11.5	9	14	36	4.8	400
KH3/4-20NPT	20	18	18	14		3/4 - 14 NPT	13.86	144	100	58	85	92	36	73	11.5	9	17	46	6.3	315

Type	DN	Bore int. diam.			RA	d1	l	L	L1	L2	L3	H	h1	h2	h3	d2	SW1	SW2	Weight [kg]	Nom. press. PN [bar]
		L	T	X																
KH3/4-10SAE	10	9	9	6		9/16-18 UNF	13	115	80	46	65	63.5	27	50	11.5	6.5	14	30	2.68	500
KH3/4-12SAE	12	9	9	10		3/4-16 UNF	15	135	100	56	80	75.5	31	60	11.5	9	14	36	4.75	400
KH3/4-20SAE	20	13	13	14		1 1/16 - 12 UN	20	144	100	58	85	91	36	73	10.5	9	17	46	6.1	315

## Spare parts (seal kit)

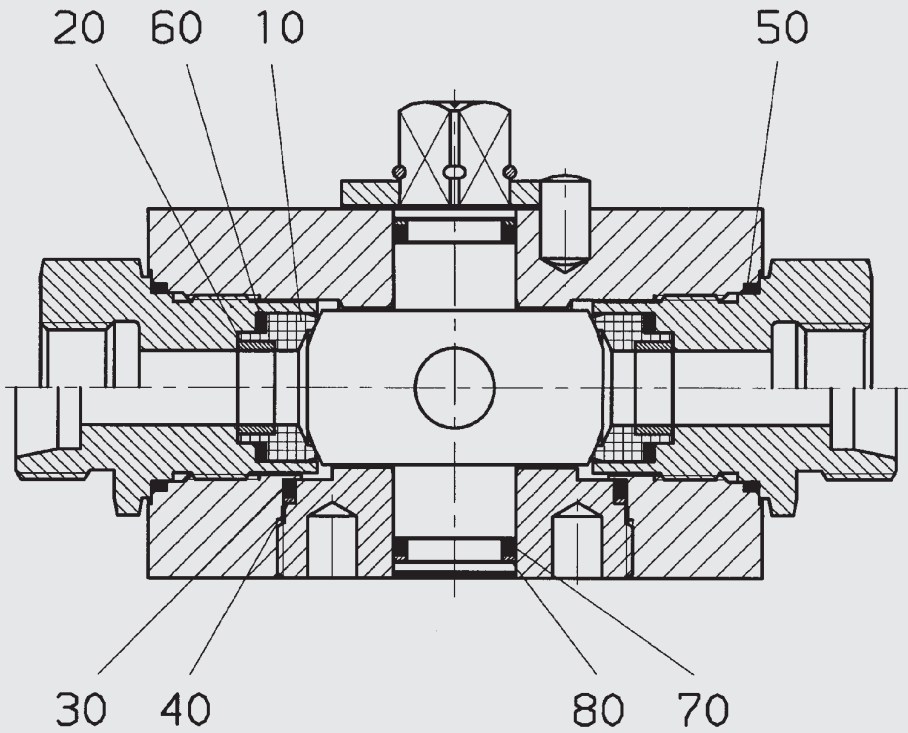

Seal kit	Order no. = part no.
DN 04/06	703 028
DN 08/10	703 017
DN 12/16	703 129
DN 20	703 029

The parts indicated by numbers in the above drawing are contained in the seal kit.

## NOTE

The information in this brochure relates to the operating conditions and applications described. For applications and operating conditions not described, please contact the relevant technical department.

The operator is always responsible for determining the product suitability for the specific application. Quantified values for product characteristics are average values for a new product that undergo a time deterioration process.

Subject to technical modifications and errors.