

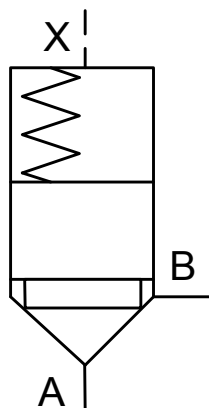

2-port slip-in cartridge valve directional function, poppet type Cone B (1: 1,6) Type L-CEE Sizes 16 up to 63

SYMBOL



Q max = 3.600 l/min
P max = 350 bar

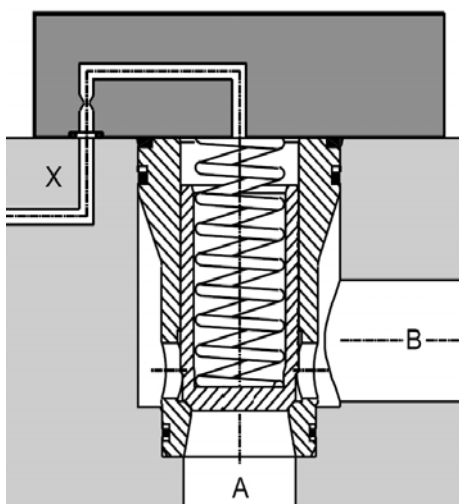

FEATURES:

- 2-port slip-in cartridge valves according to ISO 7368 with two operational ports A and B.
- valve cone without damping nose
- hydraulic control by pilot pressure applied to port X
- optional with sealing between cone and sleeve = leakagefree B <-> X (see MODEL CODE, detail "X")

FUNCTION:

The main flow through the ports A and B is hydraulically operated by a controlling pressure at port X. The cartridge valve is normally closed leakagefree A <-> B. It consists of a poppet with sleeve, cone and closing spring. The closing spring is located in the valve cone and affects the minimum operating pressure. Furthermore it is holding the valve in the unloaded position closed.

The resulting force of the pilot pressure on face A_x and the forces on ports A and B ($p_A \times A_A$, $p_B \times A_B$) affect the opening of the valve.

SPECIFICATIONS:

Operating pressure:	max. 350 bar
Nominal flow:	max. 3600 l/min
Media operating temperature range:	min. -20°C up to max. +80°C
Ambient temperature range:	min. -20°C up to max. +60°C
Mode of Construction:	2- way poppet valve
Fluids:	Hydraulic oils according DIN 1524 part 1 and 2
Filtration:	Class 21/19/16 according to ISO 4406
Viscosity:	2,8 up to 380 mm ² /s
Sealing:	FKM + PU (NBR, FKM on request)
Installation position:	optional
Manner of Mounting:	Manifold cartridge mounting
Cavity:	according to ISO 7368
Ratio:	1 : 1,6
Flow direction:	A<-->B

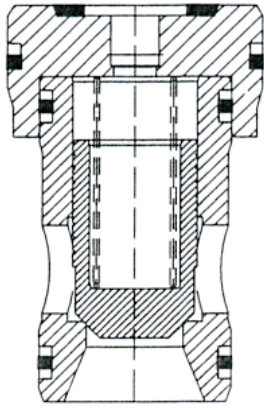

Sizes
16 - 32

Sleeve + sleeve cap + cone

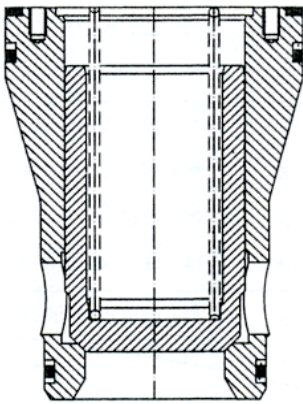

Sizes
40 - 63

Cone + sleeve

PERFORMANCE

Measured at 35 mm²/s, T-Oil 50°C

Δp bar

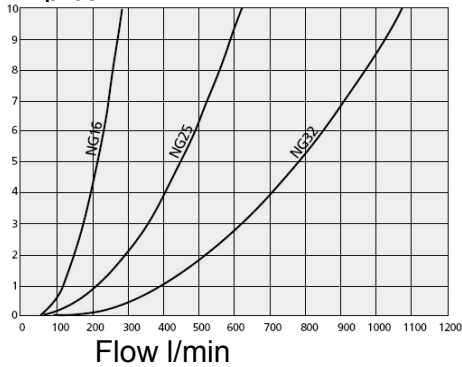

Δp bar

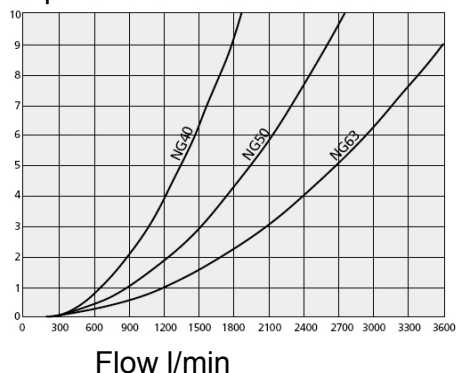

MODEL CODE

L - C E E 16 B 6 B X

Basic model

L-CEE = 2-port slip-in cartridge valve standard

Size

available sizes = NG 16, 25, 32, 40, 50, 63

Series

To be assigned by manufacturer

Model

Cavity to ISO 7368

Cone type

B = step cone 1:1,6

Sealing element at the cone

omission = without sealing between cone and sleeve

X = with sealing between cone and sleeve

(Attention: different springs necessary, call factory!)

Basic versions

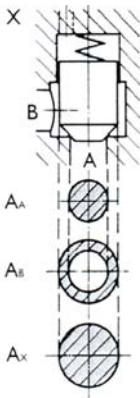

Cone B without sealing at cone						
Part No.	6061143	6061148	6061207	6061212	6061218	6061224
Cone B with sealing at cone						
Part No.	6061144	6061150	6061208	6061213	6061219	6061225
	NW16	NW25	NW32	NW40	NW50	NW63
stroke mm	6,0	12,0	14,0	15,0	20,0	24,0
A _A mm ²	123,0	227,0	452,0	804,0	1590,0	2642,0
A _A (Ref)	1,0	1,0	1,0	1,0	1,0	1,0
A _B	0,6	0,6	0,6	0,6	0,6	0,6
A _X	1,6	1,6	1,6	1,6	1,6	1,6
Control volume (A _X) cm ³	1,18	4,40	10,13	19,30	50,90	101,50
Weight (kg)	0,20	0,40	0,90	1,80	3,20	6,90
Optional springs						
not in the standard scope of delivery (for versions without sealing at cone only!*)						
Part No. 0,3 bar	6061191	6061229	6061233	6061237	6061241	6061245
Part No. 1 bar	6061204	6061230	6061234	6061238	6061242	6061247
Part No. 2 bar	6061227	6061231	6061235	6061239	6061243	6061248
Part No. 4 bar	6061228	6061232	6061236	6061240	6061244	6061249

(*versions with sealing at cone: call factory!)

DIMENSIONS

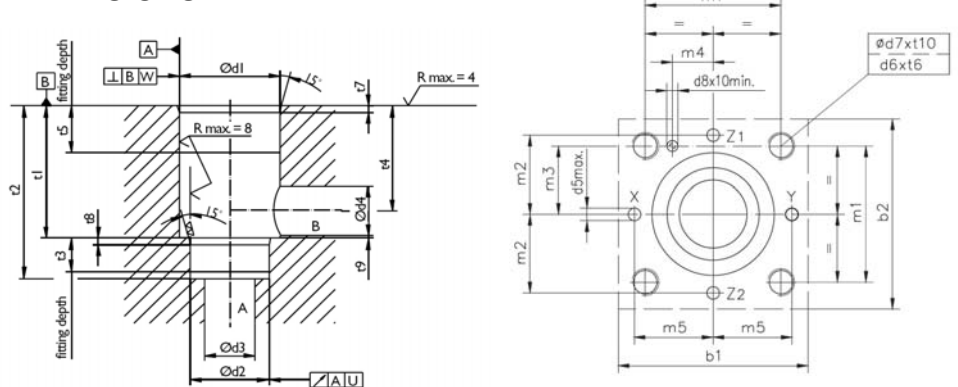

Dimensions [mm]	NG16	NG25	NG32	NG40	NG50	NG63
b1	65	85	102	125	140	180
b2	65	85	102	125	140	180
d1 H7	32	45	60	75	90	120
d2 H7	25	34	45	55	68	90
d3	16	25	32	40	50	63
d3 max	17	25	32	43	54	66
d4	16	25	32	40	50	63
d4 max	25	32	40	50	63	80
d5 max	4	6	8	10	10	12
d6	M8	M12	M16	M20	M20	M30
d7 H13	6	6	6	6	8	8
m1 ±0.2	46	58	70	85	100	125
m2 ±0.2	25	33	41	50	58	75
m3 ±0.2	23	29	35	42.5	50	62.5
m4 ±0.2	10.5	16	17	23	30	38
m5 ±0.2	25	33	41	50	58	75
t1 ±0.1	43	58	70	87	100	130
t2 ±0.1	56	72	85	105	122	155
t3	11	12	13	15	17	20
t4	34	44	52	64	72	95
t4 at d4 max	29.5	40.5	48	59	65.5	86.5
t5	20	30	30	30	35	35
t6	20	25	35	45	45	65
t7	2	2.5	2.5	3	4	4
t8	2	2.5	2.5	3	4	4
t9 cont. dim. min.	0.5	1.0	1.5	2.5	2.5	3
t10 min.	10	10	10	10	10	10
U	0.03	0.03	0.03	0.05	0.05	0.05
W	0.05	0.05	0.1	0.1	0.1	0.2

Annotation

The technical information in this brochure are relating to the operating conditions and applications.

At deviant applications and/or operating conditions please contact the technical dept.

Technical information are subject to technical modifications.

HYDAC Fluidtechnik GmbH
Justus-von-Liebig-Str. 5
66280 Sulzbach / Saar
Tel.: 06897 / 509 -0
Fax: 06897 / 509 -598
Email: flutec@hydac.com