

## Change-Over Low Pressure Ball Valves

### KHN3K

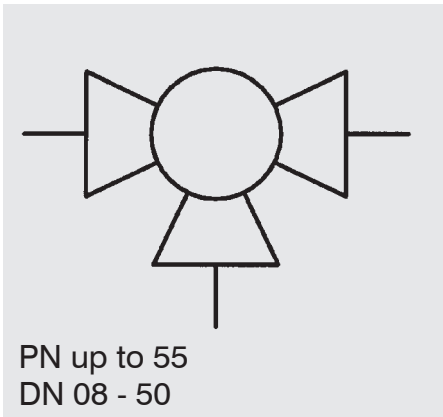

#### Model code

(also order example)

**KHN3K** **G1/2** **L** **2233** **12** **X**

#### Designation

KHN3K = change-over low pressure ball valve

#### Connection type

Thread size

#### Ball bore

L

T

#### Materials

*Housing, connection adapters*

2 = Nickel-plated brass

*Ball, control spindle*

2 = Brass, hard-chromed

*Ball seal*

3 = PTFE (Teflon)

*Control spindle seal*

3 = PTFE (Teflon)

#### Handle

12 = Aluminium clamped handle, cranked, fitted

#### Series

(Determined by manufacturer)

#### Switching functions (as supplied)

3/2 way change-over ball valve

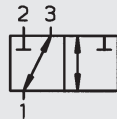

L-bore



90° switch



3/2 way change-over ball valve

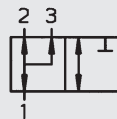

T-bore



90° switch



#### By moving the control spindle through 90°, the following switching positions can also be achieved.

3/2 way change-over ball valve

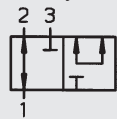

T-bore



90° switch



3/2 way change-over ball valve

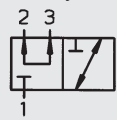

T-bore



90° switch



3/2 way change-over ball valve

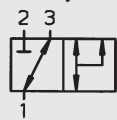

T-bore



90° switch



## Technical specifications

Connection:	Whitworth female thread to ISO 228
Mounting position:	Optional
Ambient temperature:	-20 °C to +150 °C
Nominal pressure:	Up to 55 bar
Operating fluids:	Mineral oil to DIN 51524 part 1 and part 2, water and compressed air (other media on request)
Temperature of operating fluid:	-20 °C to +150 °C

## DIMENSIONS

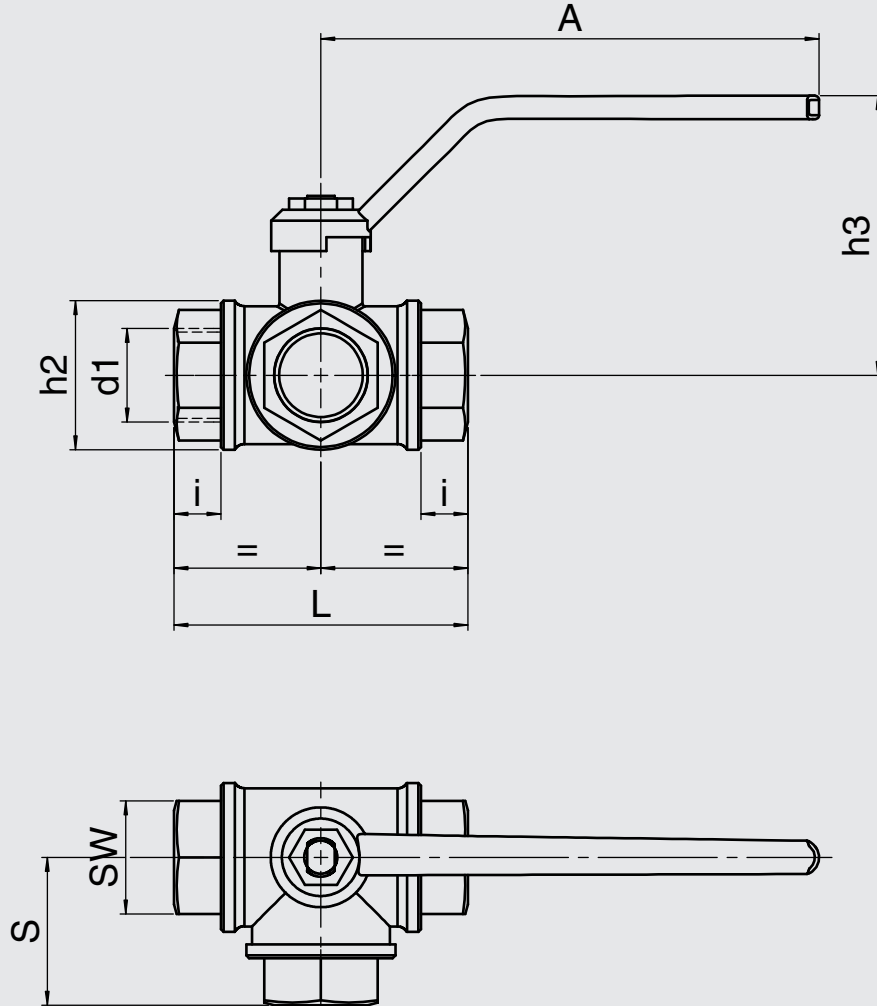

Type	Ball bore	Size d1	L [mm]	h2 [mm]	SW	A [mm]	i [mm]	Nominal bore DN	S [mm]	h3 [mm]	Nominal pressure PN [bar]	[psi]	Weight [kg]
KHN3K-G1/4	L, T	1/4"	77	39	22	125	19	8	38.5	65.5	55	800	0.78
KHN3K-G3/8	L, T	3/8"	77	39	22	125	19	10	38.5	65.5	55	800	0.74
KHN3K-G1/2	L, T	1/2"	77	39	27	125	19	15	38.5	65.5	50	725	0.77
KHN3K-G3/4	L, T	3/4"	92	47	34	145	23	20	46.5	83.5	50	725	1.26
KHN3K-G1	L, T	1"	104	55	41	170	25	25	52.5	96.5	45	650	1.91
KHN3K-G1 1/4	L, T	1 1/4"	118	65	50	170	27	32	59.5	101.5	35	500	2.64
KHN3K-G1 1/2	L, T	1 1/2"	138	79	57	170	31	40	69.5	105.5	35	500	4.2
KHN3K-G2	L, T	2"	162	93	70	260	36	50	81.5	139.5	35	500	6.66

## NOTE

The information in this brochure relates to the operating conditions and applications described.

For applications and operating conditions not described, please contact the relevant technical department.

The operator is always responsible for determining the product suitability for the specific application. Quantified values for product characteristics are average values for a new product that undergo a time deterioration process.

Subject to technical modifications and errors.

**HYDAC Accessories GmbH**  
Hirschbachstr. 2  
**66280 Sulzbach/Saar**  
Tel.: +49 (0)6897 - 509-01  
Fax: +49 (0)6897 - 509-1009  
Internet: [www.hydac.com](http://www.hydac.com)  
E-Mail: [info@hydac.com](mailto:info@hydac.com)