

2/2-way Coaxial Valve

CX06F to CX08F Pilot operated Flange version

Model code
(also example order)

CX 06F 2/2 F C 2 10 064 PV

Switching function

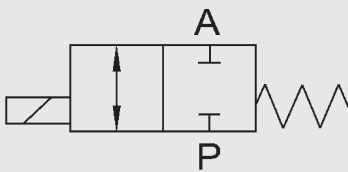

NC (closed when de-energised)

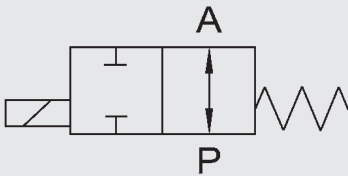

NO (open when de-energised)

Type

CX06F = Series CX06F
CX07F = Series CX07F
CX08F = Series CX08F

Ways

2/2 = Number of ways

Control

F = External pilot

Switching function

C = NC - closed when de-energised
O = NO - open when de-energised*

Body material

1 = Free from non-ferrous metals*
2 = Brass
3 = Brass, nickel-plated*
4 = 1.4305*
5 = 1.4571*
6 = Steel, zinc-plated
7 = Steel, nickel-plated

Valve sizes

15 = DN 15
20 = DN 20
25 = DN 25
32 = DN 32
40 = DN 40
50 = DN 50

Pressure range

016 = PN16 CX06F
040 = PN40 CX06F
063 = PN63 CX06F
064 = PN64 CX06F
100 = PN100 CX07F
160 = PN160 CX08F

Options

PV... = Pilot valve (...see Accessories section)

Ordering data

- Nominal size of flange
- Flange standard
- Valve size
- NC/NO function
- Operating pressure
- Flow rate
- Medium
- Medium temperature
- Ambient temperature
- Supply voltage

*optional

Technical specifications

Control	2/2 way valve, external pilot
Nominal size	DN 15 to DN 50
Pressure range (see table)	CX06F - 2/2 DN 15 - 50 PN 0 to PN 64 CX07F - 2/2 DN 15 - 50 PN 0 to PN 100 CX08F - 2/2 DN 15, DN 25 PN 0 to PN 160
Ports	Flange
Housing material	Zinc-plated steel, nickel-plated steel, 1.4571
Seal material	Static: FKM Dynamic: FKM / CX06F PTFE / CX07F, CX08F Seat seal: PTFE
Back-pressure resistant	Up to 16 bar
Media	Gaseous, liquid, contaminated
Direction of flow	P → A as marked A → P max. 16 bar
Temperature of medium	-10 °C to +100 °C
Ambient temperature	-10 °C to +50 °C
Actuating part	Double acting piston with return spring
Installation position	In any position
Limit switch	Magnetic field sensor*
Installation	Mounting bracket*

Pneumatic part (for pilot valve option)

Control	5/2-way pilot valve
Interface	Namur
Control pressure	3 to 8 bar
Air requirement	approx. 7 cm ³ / stroke
Pilot ports 2+4	G1/4
Switching speed	CX valve can be adjusted steplessly by adjusting the supply to the pilot valve
Switching times	Open/close 50-1000 ms depending on control pressure, pilot valve and meter-out control

Note: Connecting an air line filter / water trap upstream will extend the service life of the valves

Electrical part

Supply voltage	DC: 24 V AC: 230 V 40 - 60 Hz
Electrical part	DC: DC solenoid AC: DC solenoid with integrated rectifier
Connection	Female connector to industrial standard, Form B Female connector to DESINA M12x1 * Connector with LED (transparent housing) with varistor*
Voltage tolerance	+ / - 10% to VDE 0580
Duty cycle	100%
Protection class	IP 65 when connector is fitted correctly

We would be happy to discuss your requirements for further options and accessories.

*optional

Sectional drawing

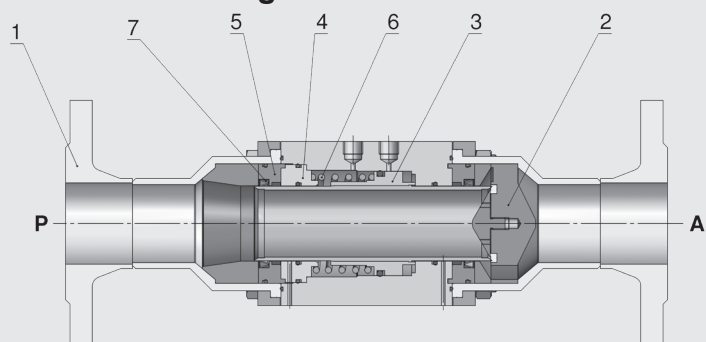

Item	Designation	Qty.
1	Flange connector	2
2	Valve seat	1
3	Piston / control tube	1
4	Actuation disc	1
5	Guide disc	2
6	Spring	1
7	PTFE rod seal	2



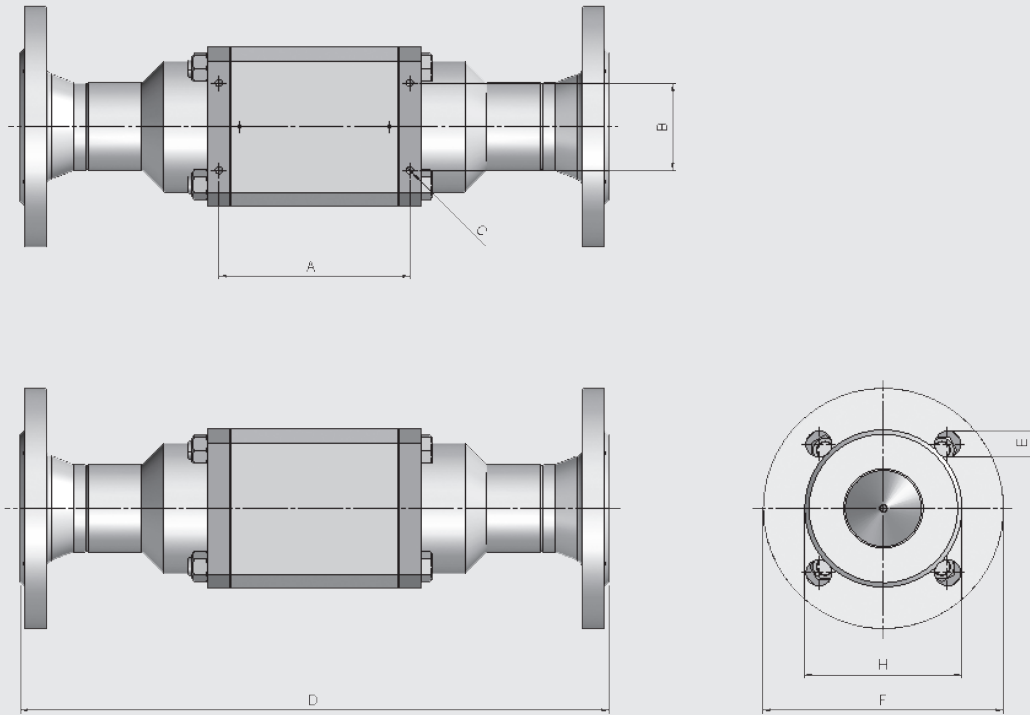

Dimensions

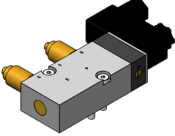
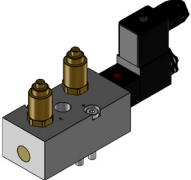
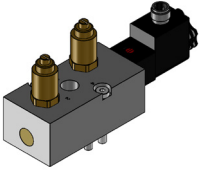

Series	Flange standard		PN	DN (Flange)	DN (Valve)	Pressure [bar]	Kv value [m ³ /h]	a [mm]	B [mm]	C	E [mm]	E [mm]	F [mm]	H [mm]	Weight [kg]
	DIN	EN													
CX06F	2633	-	16	15	15	0 - 16	6.6	100	-	M5	242	14	95	65	3.6
	2633	-	16	20	20	0 - 16	9.4	108	-	M5	269	14	105	75	5.4
	2633	-	16	25	25	0 - 16	14.5	121	-	M5	302	14	115	85	6.7
	2633	-	16	32	32	0 - 16	20.0	122	50	M6	324	18	140	100	9.1
	2633	-	16	40	40	0 - 16	38.2	131	60	M6	385	18	150	110	12.9
	2633	1092-1 Type 11	16	50	50	0 - 16	47.2	131	60	M6	385	18	165	125	14.5
	2635	1092-1 Type 11	40	15	15	0 - 40	6.6	100	-	M5	242	14	95	65	3.8
	2635	1092-1 Type 11	40	20	20	0 - 40	9.4	108	-	M5	269	14	105	75	5.6
	2635	1092-1 Type 11	40	25	25	0 - 40	14.5	121	-	M5	302	14	115	85	7.1
	2635	1092-1 Type 11	40	32	32	0 - 40	20.0	122	50	M6	324	18	140	100	9.5
	2635	1092-1 Type 11	40	40	40	0 - 40	38.2	131	60	M6	385	18	150	110	13.5
	2635	1092-1 Type 11	40	50	50	0 - 40	47.2	131	60	M6	385	18	165	125	14.9
	-	1092-1 Type 11	63	50	50	0 - 63	47.2	131	60	M6	385	22	180	135	18.1
2636	-	64	50	50	0 - 64	47.2	131	60	M6	385	22	180	135	18.1	
CX07F	2637	1092-1 Type 11	100	15	15	0 - 100	6.6	100	-	M5	242	14	105	75	4.8
	-	1092-1 Type 11	100	20	20	0 - 100	9.4	108	-	M5	269	18	130	90	7.6
	2637	1092-1 Type 11	100	25	25	0 - 100	14.5	121	-	M5	302	18	140	100	9.7
	-	1092-1 Type 11	100	32	32	0 - 100	20.0	122	50	M6	324	22	155	110	11.9
	2637	1092-1 Type 11	100	40	40	0 - 100	38.2	131	60	M6	385	22	170	125	17.3
	2637	1092-1 Type 11	100	50	50	0 - 100	47.2	131	60	M6	385	26	195	145	20.5
CX08F	2638	1092-1 Type 11	160	15	15	0 - 160	6.6	100	-	M5	242	14	105	75	4.8
	2638	1092-1 Type 11	160	25	25	0 - 160	14.5	121	-	M5	302	18	140	100	9.7

Note: Mounting brackets are not included with the standard model.

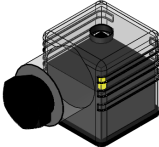
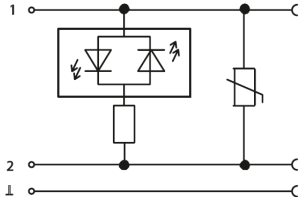
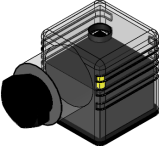
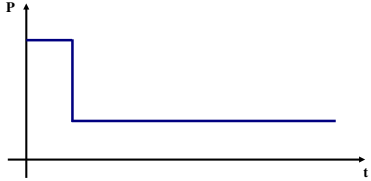
Accessories

	<p>Mounting bracket mechanical option = HW</p>	<p>On request</p>
	<p>5/2-way pilot valve (NAMUR) for flange-mounting = PV</p>	<p>Connections on side 24V DC 230V 50Hz</p>
	<p>5/2-way pilot valve (NAMUR) for flange-mounting = PV</p>	<p>Connections on top 24V DC 230V 50Hz</p>
	<p>5/2-way pilot valve (NAMUR) for flange-mounting = PV</p>	<p>Connections on top Solenoid M12x1 24V DC 230V 50Hz</p>
	<p>Meter-out control = DR</p>	<p>G$\frac{1}{8}$ G$\frac{1}{4}$</p>
	<p>Silencer in sintered bronze = SD</p>	<p>G$\frac{1}{8}$ G$\frac{1}{4}$</p>
	<p>Female connector with LED electrical option = LED</p>	
	<p>Female connector with power reduction 24 V DC Form A electrical option = LS</p>	
	<p>Special explosion protection II 2G Ex m II T4 II 3D IP65 T130 °C electrical option = EX</p>	<p>Note: The operating pressure is reduced by approx. 20% on the Ex version.</p>

We would be happy to discuss your requirements for further options and accessories

NOTE

The information in this brochure relates to the operating conditions and applications described.

For applications and operating conditions not described, please contact the relevant technical department.

Subject to technical modifications.

HYDAC Accessories GmbH

Hirschbachstr. 2

66280 Sulzbach/Saar

Tel.: +49 (0)6897 - 509-01

Fax: +49 (0)6897 - 509-1009

Internet: www.hydac.com

E-Mail: info@hydac.com