



## Clogging Indicators for Process Filters

### 1. TECHNICAL SPECIFICATIONS

#### 1.1 GENERAL

HYDAC clogging indicators are designed to indicate visually and/or electrically when the filter elements must be cleaned or changed. The use of clogging indicators guarantees both the operational safety of the system and the efficient utilisation of the filter elements.

#### 1.2 SEALS

V (=Viton) or T (=FEP encapsulated)

#### 1.3 CONSTRUCTION

Differential pressure indicators are used on all process filters. They react to the pressure differential between the filter inlet and the filter outlet, which rises as the level of contamination in the element increases.

Simplest fitting of the differential pressure indicator:  
G 1/2" cavity  
(acc. HYDAC works standard HN 28-22)

The differential pressure indicator type V01 is piped up separately.

For duplex filter housings, the differential pressure indicators are connected using an adaptor block.

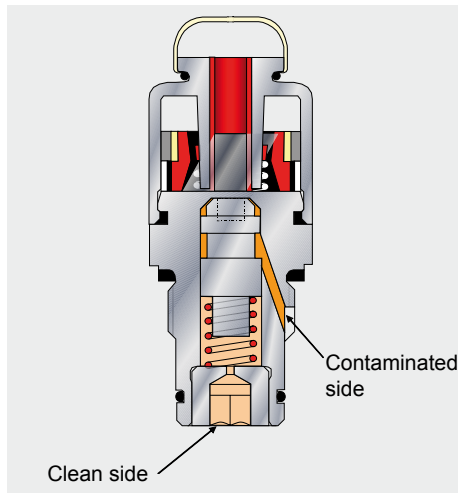

#### 1.4 SPECIAL INDICATORS

**Electrical ATEX indicators:**  
Optional: electrical indicator for process filters for use in potentially explosive atmospheres subject to the ATEX equipment directive 94/9/EC and the ATEX operator directive 1999/92/EC.

#### 1.5 TORQUE VALUES - DIFFERENTIAL PRESSURE INDICATORS

**Note:**  
The clogging indicators must only be tightened or adjusted on the spanner flats.

- PVD..B.1: SW27
- PVD..C.0: SW30
- PVD..D.0/L...: SW30
- max. torque value: 100 Nm

## 2. QUICK SELECTION: CLOGGING INDICATORS ACCORDING TO FILTER TYPE

Please select from the table the clogging indicator required for your filter.

Type	Filter types				
	PRFL PRFLD	PRFS PRFSD	PFM PFH	EDF	PMRF PMRFD
PVD ..B	●	●	●	●	●
PVD ..C	●	●	●	●	●
PVD ..D	●	●	●	●	●
V01 ...VZ	●	●	on request		●
Differential pressure gauge	●	●	on request		●

### 3. MODEL CODE

PVD 2 D. 0 / -L24

#### Differential pressure clogging indicator

PVD = Clogging indicator

V01 = Clogging indicator

#### Cracking pressure

0.8 = +0.8 bar (only for V01 indicator)

1 = +1 bar (PVD indicator)

1.5 = +1.5 bar (PVD indicator)

2 = +2 bar (all clogging indicators)

3 = +3 bar (PVD indicator)

4.3 = +4.3 bar (only for V01 indicator)

5 = +5 bar (only for PVD indicator)

8 = +8 bar (only for PVD indicator)

#### Type of clogging indicator

B. = visual indicator with automatic reset

C. = electrical indicator

D. = visual/electrical indicator

VZ = visual/analogue indicator with 75% and 100% switch contacts

#### Modification number

0 = all clogging indicators

1 = only B. type

#### Supplementary details (only PVD)

-L24 = light with 24 V

-L48 = light with 48 V

-L110 = light with 110 V

-L220 = light with 220 V

#### Differential pressure gauge DS11 electrical

Display range: 0 - 1.6 bar

Permitted operating pressure: 25 bar

Pressure chamber in aluminium: Order no. 639311

Pressure chamber in stainless steel: Order no. 639586

Other versions available on request

## 4. SPECIFICATIONS

### PVD x B.x

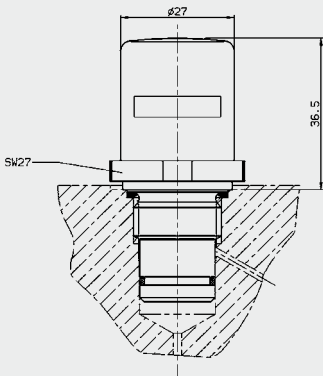
	Type of indication	Visual, red/green band Automatic reset	
	Weight	110 g	
	Cracking pressure or indication range	1 bar ± 10%    3 bar ± 10% 1.5 bar ± 10%    5 bar ± 10% 2 bar ± 10%    8 bar ± 10%	
	Perm. operating pressure	420 bar	
	Perm. temperature range	-20°C to +100°C	
	Thread	G 1/2	
	Max. torque value	100 Nm	
	Switching type	–	
	Max. switching voltage	–	
	Electrical connection	–	
	Max. switching voltage at resistive load	–	
	Switching capacity	–	
	Protection class acc. DIN 40050	–	
	Order example	PVD 2 B.1	

### PVD x C.x

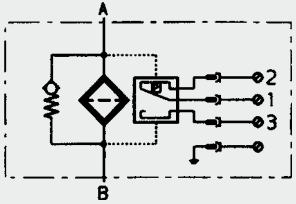
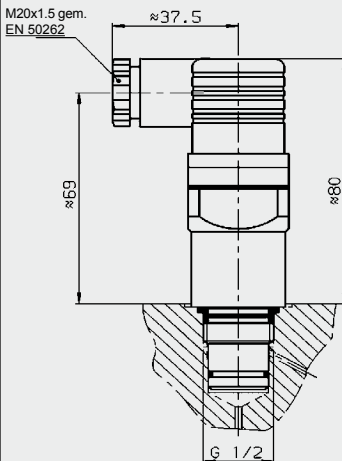
 	Type of indication	Electrical switch	
	Weight	220 g	
	Cracking pressure or indication range	1 bar ± 10%    3 bar ± 10% 1.5 bar ± 10%    5 bar ± 10% 2 bar ± 10%    8 bar ± 10%	
	Perm. operating pressure	420 bar	
	Perm. temperature range	-20°C to +100°C	
	Thread	G 1/2	
	Max. torque value	100 Nm	
	Switching type	N/C or N/O (change-over contacts)	
	Max. switching voltage	230 V	
	Electrical connection	Male connection M20x1.5 acc. EN 50262 Female connector acc. DIN 43650	
	Max. switching voltage at resistive load	60 W = 100 VA ~	
	Switching capacity	Ohmic 3 A at 24 V = Ohmic 0.03 to 5 A at max. 230 V ~	
	Protection class acc. DIN 40050	IP 65 (only if the connector is wired and fitted correctly)	
	Order example	PVD 5 C.0	

### PVD x D.x /-L...

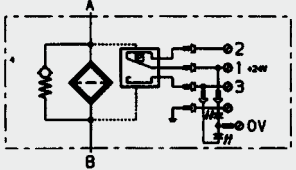
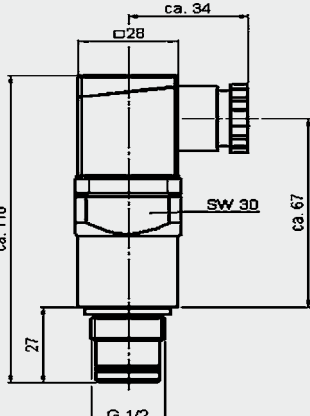
 	Type of indication	Visual indicator and electrical switch	
	Weight	250 g	
	Cracking pressure or indication range	1 bar ± 10%    3 bar ± 10% 1.5 bar ± 10%    5 bar ± 10% 2 bar ± 10%    8 bar ± 10%	
	Perm. operating pressure	420 bar	
	Perm. temperature range	-20°C to +100°C	
	Thread	G 1/2	
	Max. torque value	100 Nm	
	Switching type	N/C or N/O (change-over contacts)	
	Max. switching voltage	24, 48, 110, 230 V depending on the light insert	
	Electrical connection	Male connection M20x1.5 acc. EN 50262 Female connector acc. DIN 43650	
	Max. switching voltage at resistive load	60 W = 100 VA ~	
	Switching capacity	Ohmic 3 A at 24 V = Ohmic 0.03 to 5 A at max. 230 V ~	
	Protection class acc. DIN 40050	IP 65 (only if the connector is wired and fitted correctly)	
	Order example	PVD 2 D.0 /-L24	

V01 x VZ.x

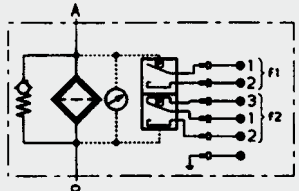
 	Type of indication	Visual/analogue indicator and 1 electrical switching contact at 75% and 100% of the cracking pressure	
	Weight	650 g	
	Cracking pressure or indication range	0.8 bar ± 10% 2.0 bar ± 10% 4.3 bar ± 10%	
	Perm. operating pressure	160 bar	
	Perm. temperature range	-20°C to +100°C	
	Thread	G ¼	
	Max. torque value	-	
	Switching type	75% - N/O contact 100% - N/C contact	
	Max. switching voltage	250 V	
	Electrical connection	Threaded connection M20x1.5 acc. EN 50262	
	Max. switching voltage at resistive load	75% contact 120 W = 120 VA ~	100% contact 30 W = 60 VA ~
	Switching capacity	Ohmic 2.5 A at 24 V = Ohmic 1 A at 250 V ~	
	Protection class acc. DIN 40050	IP 55	
	Order example	V01 2 VZ.0	

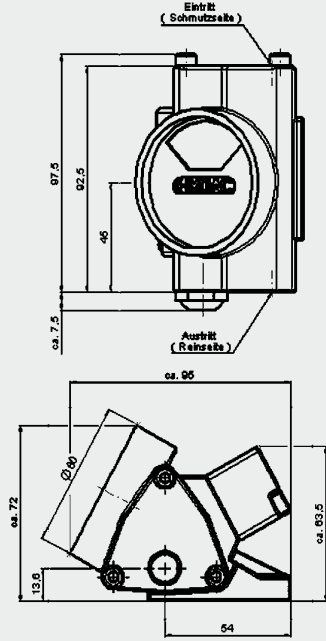

Differential pressure gauge DS11

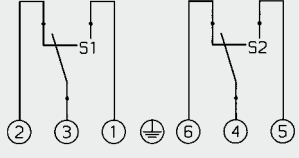
 	Type of indication	2 microswitches, 1-pole change-over contacts, can be adjusted manually to recommended set values	
	Weight	1.2 - 3.5 kg	
	Cracking pressure or indication range	0 - 1.6 bar 0 - 4 bar on request	
	Perm. operating pressure	25 bar, 40 bar on request	
	Perm. temperature range	-10°C to +100°C	
	Thread	G ¼	
	Max. torque value	-	
	Switching type	Change-over contacts	
	Max. switching voltage	U~max = 250 V AC U~max = 30 V DC	
	Electrical connection	Hard-wired numbered cable, cable connector, 7 pole plug-in connection	
	Max. switching voltage at resistive load	I <sub>max</sub> = 5 A, I <sub>max</sub> = 0.4 A,	P <sub>max.</sub> = 250VA P <sub>max.</sub> = 10 W
	Switching capacity	-	
Protection class to DIN 40050	IP 55		
Order numbers	Pressure chamber in aluminium: 639311 Pressure chamber in stainless steel: 639586		

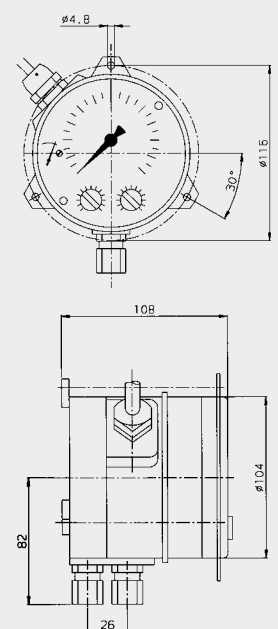

NOTE

The information in this brochure relates to the operating conditions and applications described.  
For applications or operating conditions not described, please contact the relevant technical department.  
Subject to technical modifications.

**HYDAC** Process Technology GmbH  
Am Wrangelflöz 1  
D-66538 Neunkirchen  
Tel.: +49 (0)6897 - 509-1241  
Fax: +49 (0)6897 - 509-1278  
Internet: www.hydac.com  
E-Mail: prozess-technik@hydac.com