

## 2/2-way coaxial valve

### CX03F to CX05F direct acting

### Flange version

**Model code**  
(also example order)

**CX03F 2/2 D C 2 20 016 24V ...**

### Switching function

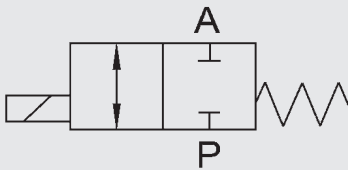

NC (closed when de-energised)

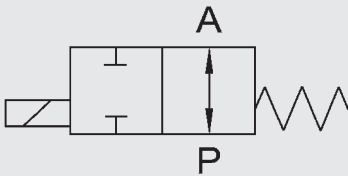

NO (open when de-energised)

### Order data

- Nominal size
- Connection
- NC/NO function
- Operating pressure
- Flow rate
- Fluid
- Temperature of fluid
- Ambient temperature
- Supply voltage

**!** If order details or application data are inaccurate or incomplete, there is a risk that the technical configuration of the valves may not be correct for the desired use. This may result in the physical and/or chemical characteristics of the materials or seals used not being adequate for the intended use.

### Designation

CX03F = series CX03F

CX05F = series CX05F

### Ways

2/2 = number of ways

### Control

D = direct

### Switching function

C = NC - closed when de-energised

O = NO - open when de-energised\*

### Body material

1 = free from non-ferrous metals\*

2 = brass

3 = brass, nickel-plated\*

4 = 1.4305\*

5 = 1.4571\*

6 = steel, zinc-plated

7 = steel, nickel-plated

### Valve sizes

15 = DN 15

20 = DN 20

25 = DN 25

32 = DN 32

40 = DN 40

50 = DN 50

### Pressure range

016 = PN16 CX03F

040 = PN40 CX03F

100 = PN100 CX05F

### Supply voltage

24V = 24 V DC

230V = 230 V AC 40 - 60 Hz

Special voltages on request!

### Options

see accessories

\*optional

## Technical specifications

Control	2/2-way valve, direct acting
Nominal size	DN 15 to DN 50
Pressure range (see table)	CX03F - 2/2 DN 15 - 50 PN 0 to PN 16 CX03F - 2/2 DN 15 - 32 PN 0 to PN 40 CX05F - 2/2 DN 15 - 32 PN 0 to PN 100
Connection	Flange
Body material	Zinc-plated steel, nickel-plated steel, 1.4571
Seal material	Static: FKM Dynamic: PTFE Seat seal: FKM CX03F PTFE CX05F
Back-pressure resistant	up to 16 bar
Vacuum	Leakage rate <math>10^{-6}</math> mbar•l/s *
Media	Gaseous, liquid, contaminated
Abrasive operating fluids	On request
Flow direction	P → A as marked A → P max. 16 bar
Temperature of medium	-10 °C to +100 °C
Ambient temperature	-10 °C to +50 °C
Mounting position	No orientation restrictions
Limit switch	Inductive*
Fixing	Mounting bracket*

## Electrical part

Supply voltage	DC: 24 V AC: 230 V 40-60 Hz
Electrical part	DC: DC solenoid AC: DC solenoid with integrated rectifier
Connection	Female connector to DIN EN 175301-803 Form A, Female connector to DESINA M12x1*
Voltage tolerance	±10 % to VDE 0580
Duty cycle	100 % duty cycle
IP class	IP 65 when connector plug is fitted

 The material specification refers exclusively to the valve connection parts in contact with the medium.

\*optional

## Dimensions

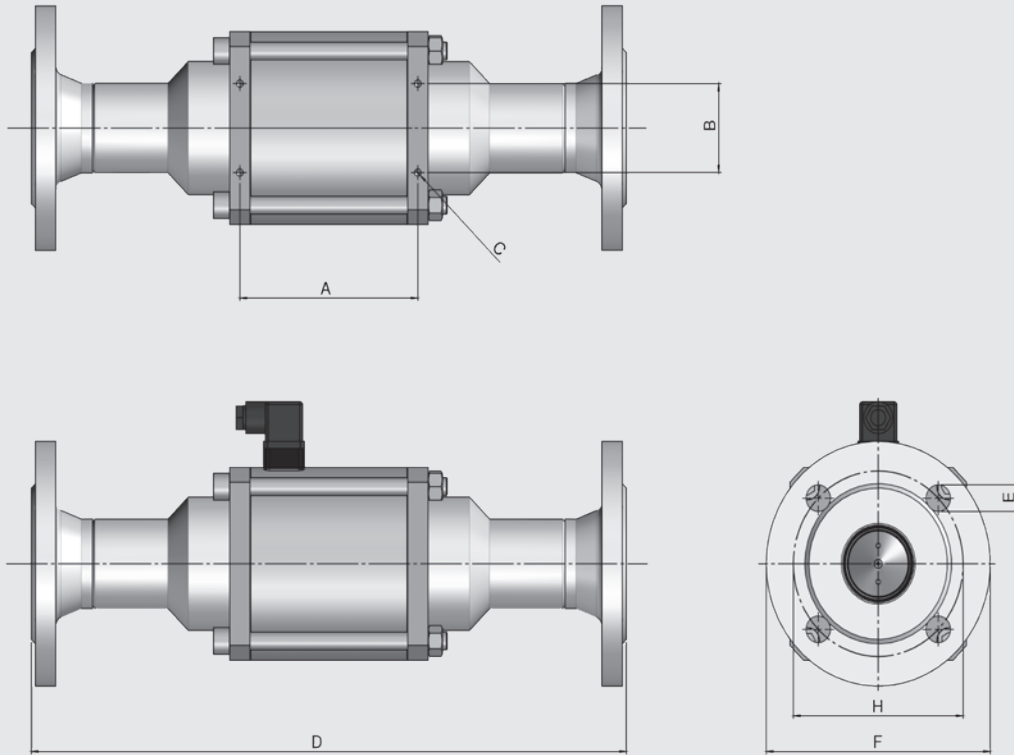



Series	Flange standard		PN	DN (Flange)	DN (Valve)	Pressure [bar]	Kv value [m³/h]	Power consumption [W]		A [mm]	B [mm]	C	D [mm]	E [mm]	F [mm]	H [mm]	Weight [kg]
	DIN	EN						24 V DC	230 V 50 Hz								
CX03F	2633	-	16	15	15	0 - 16	5.2	40	45	100	-	M5	242	14	95	65	4.4
	2633	-	16	20	20	0 - 16	7.0	45	53	108	-	M5	269	14	105	75	6.8
	2633	-	16	25	25	0 - 16	12.3	60	68	121	-	M5	302	14	115	85	8.5
	2633	-	16	32	32	0 - 16	20.0	73	76	122	50	M6	324	18	140	100	14.6
	2633	-	16	40	40	0 - 16	45.7	73	91	131	60	M6	385	18	150	110	19.3
	2633	1092-1 type 11	16	50	50	0 - 16	47.2	73	91	131	60	M6	385	18	165	125	20.9
	2635	1092-1 type 11	40	15	15	0 - 40	5.2	40	45	100	-	M5	242	14	95	65	4.6
	2635	1092-1 type 11	40	20	20	0 - 40	7.0	45	53	108	-	M5	269	14	105	75	7.0
	2635	1092-1 type 11	40	25	25	0 - 40	12.3	60	68	121	-	M5	302	14	115	85	8.9
	2635	1092-1 type 11	40	32	32	0 - 40	20.0	73	76	122	50	M6	324	18	140	100	15.0
CX05F	2637	1092-1 type 11	100	15	15	0 - 100	5.2	50	55	100	-	M5	242	14	105	75	5.6
	-	1092-1 type 11	100	20	20	0 - 100	7.0	53	59	108	-	M5	269	18	130	90	9.0
	2637	1092-1 type 11	100	25	25	0 - 100	12.3	77	85	121	-	M5	302	18	140	100	11.5
	-	1092-1 type 11	100	32	32	0 - 100	20.0	73	76	122	50	M6	324	22	155	110	17.2
	2637	1092-1 type 11	100	40	32	0 - 100	20.0	73	76	131	60	M6	324	22	170	125	19.0

**Notice:** Mounting brackets are not included with the standard model.

 The valves are technically configured for specific media and applications. This may result in deviations from the general information given in the data sheet in terms of the design, sealing materials and specifications.

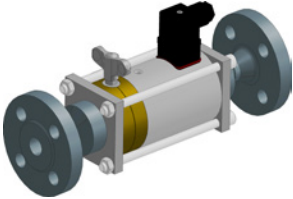
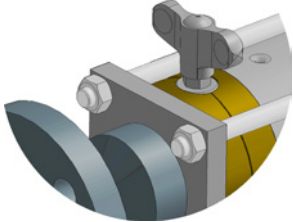
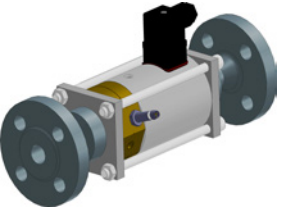
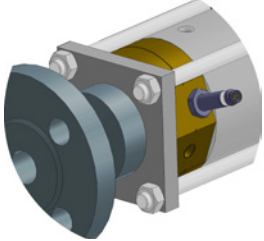
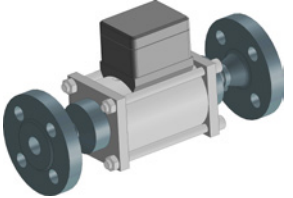
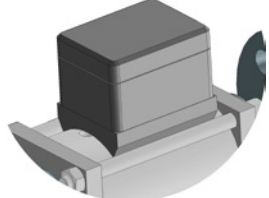
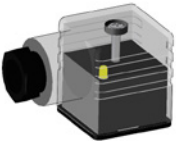
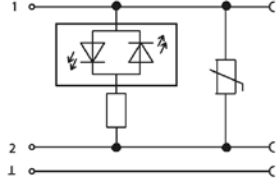
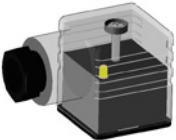
## Accessories

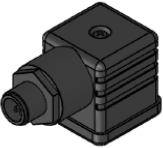
	<p><b>Mounting brackets</b> (on request) mechanical option = <b>HW</b></p>	
	<p><b>Manual override</b> mechanical option = <b>HT</b></p>	
	<p><b>Position indicator, inductive</b> electrical option = <b>1I</b> (open or closed) electrical option = <b>2I</b> (open and closed)</p>	
	<p><b>Terminal box</b> Protection class: IP 65 PG11 gland electrical option = <b>PG</b></p>	
	<p><b>Female connector with LED</b> electrical option = <b>LED</b></p>	
	<p><b>Female connector with power reduction</b> <b>24 V DC</b> <b>Form A</b> electrical option = <b>LS</b></p>	
	<p><b>Female connector M12x1</b> electrical option = <b>M12</b></p>	

We would be happy to discuss your requirements for further options and accessories

### NOTE

The information in this brochure relates to the operating conditions and applications described. For applications and operating conditions not described, please contact the relevant technical department.

The operator is always responsible for determining the product suitability for the specific application. Quantified values for product characteristics are average values for a new product that undergo a time deterioration process.

Subject to technical modifications and errors.

### HYDAC Accessories GmbH

Hirschbachstr. 2

**66280 Sulzbach/Saar**

Tel.: +49 (0)6897 - 509-01

Fax: +49 (0)6897 - 509-1009

Internet: [www.hydac.com](http://www.hydac.com)

E-Mail: [accessories@hydac.com](mailto:accessories@hydac.com)